

ROBIN IQECO31, 32, 35, 38

BACnet MS/TP Terminal Unit Controllers

IQECO31, 32, 35, 38 BACnet MS/TP Terminal Unit Controllers

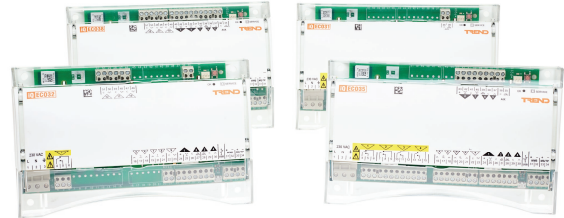

BACnet™ is a trademark of ASHRAE.



212205

Note: IQECO 32 is not eubac approved.

Description

The IQ™ECO31, 32, 35 and 38 are terminal unit controllers for use with BACnet over MS/TP. They have from 9 to 18 I/O channels, and the ability to download a fixed strategy from a library.

They can communicate with other IQECOs over the BACnet MS/TP network, and with Trend devices via an IQ4™NC. A Wallbus port is also provided for use with a room display.

Features

- Fully compatible with the Trend system
- BACnet over MS/TP (WSP certified)
- Non-volatile memory, no battery required
- 230 Vac or 24 Vac input power versions
- Inputs configurable by software (no links)
- Energy efficient strategies available
- eu.bac certified strategies available

Physical

IQECO31/24VAC

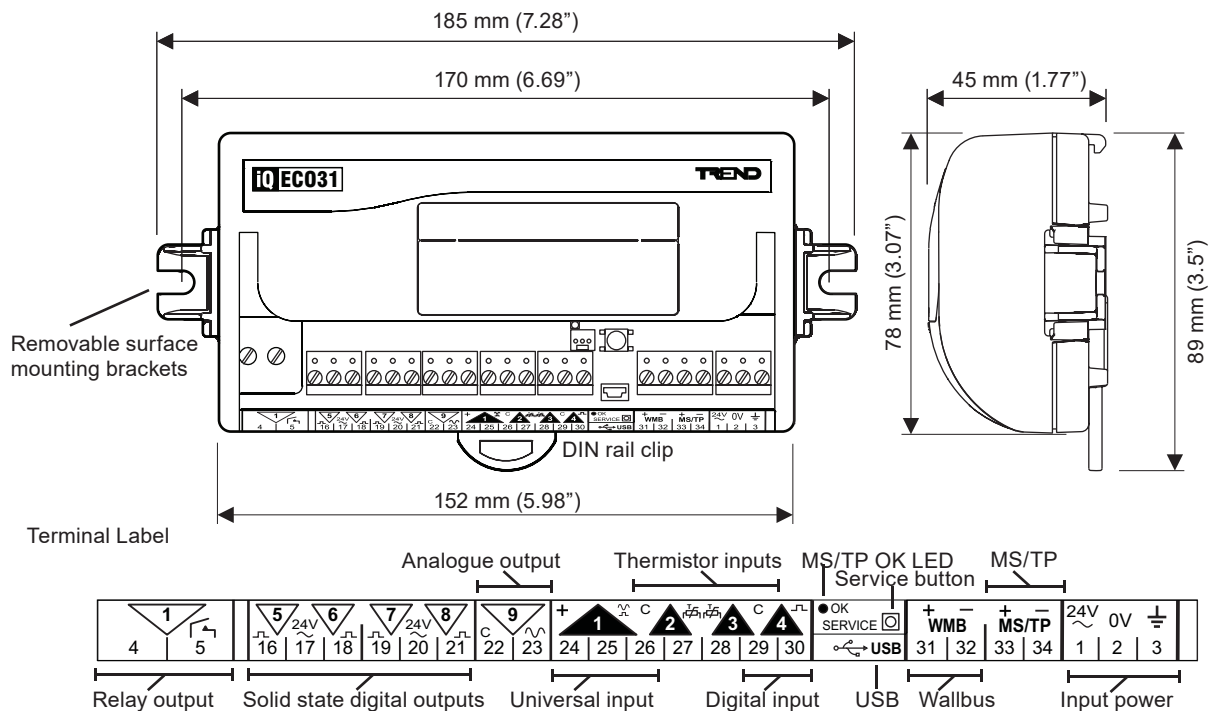



Physical (continued)

IQECO31/230

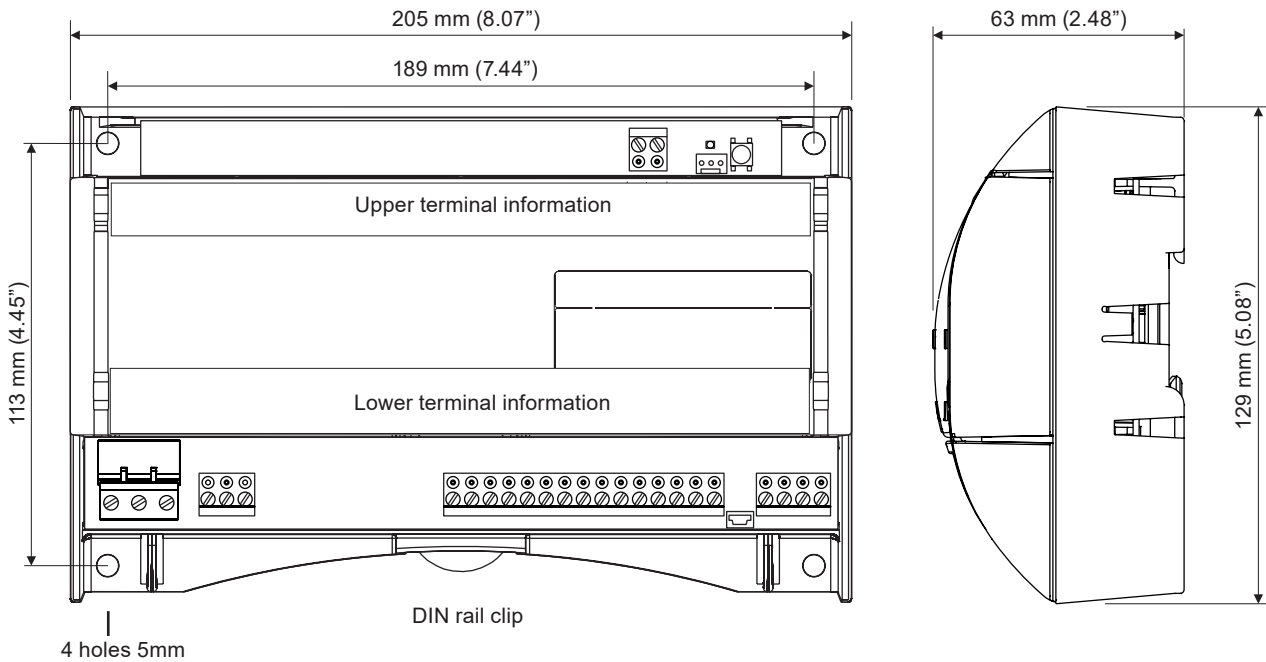

Terminal Labels
Upper Label

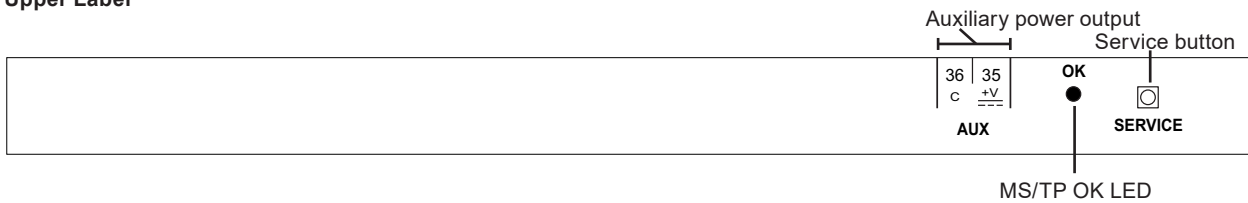

Lower Label

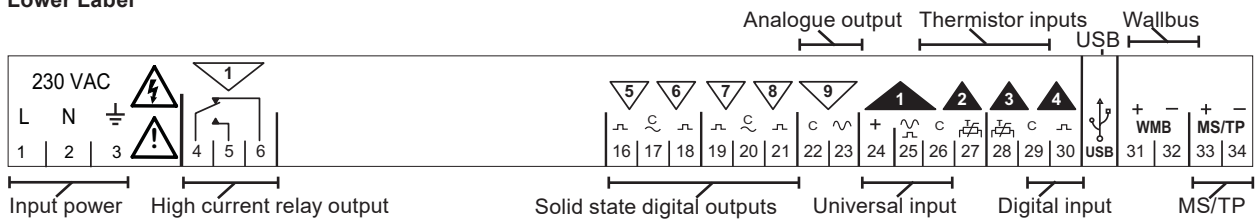

IQECO32

Dimensions as IQECO31/230

Upper Label

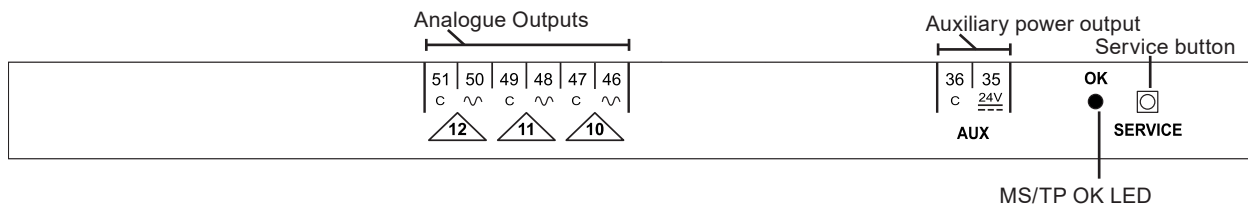

Lower Labels
IQECO32/230

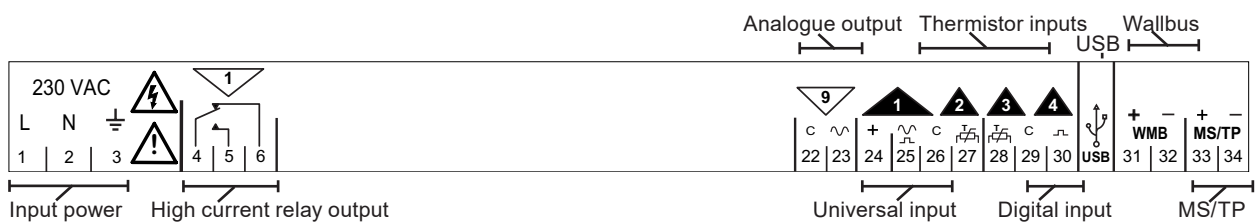



IQECO32/24VAC

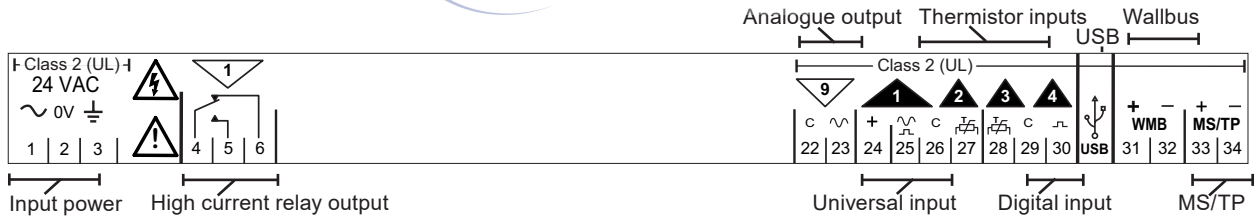

IQECO35

Dimensions as IQECO31/230

Upper Label

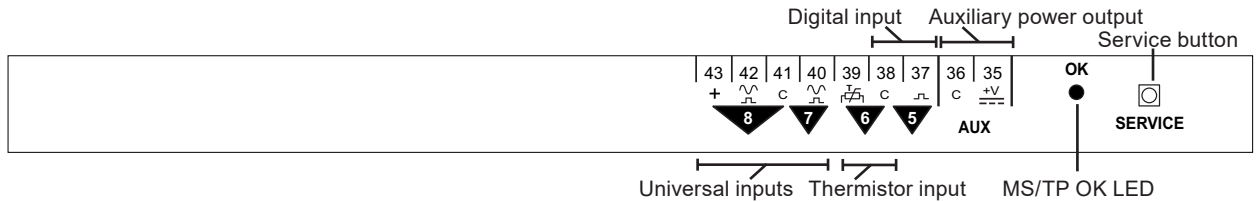

Lower Labels

IQECO35/230

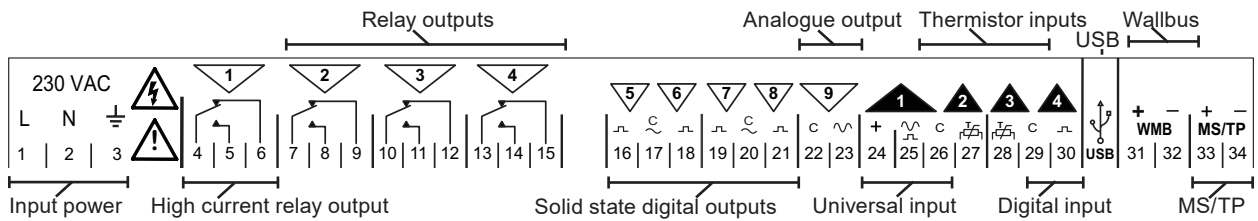

IQECO35/24VAC

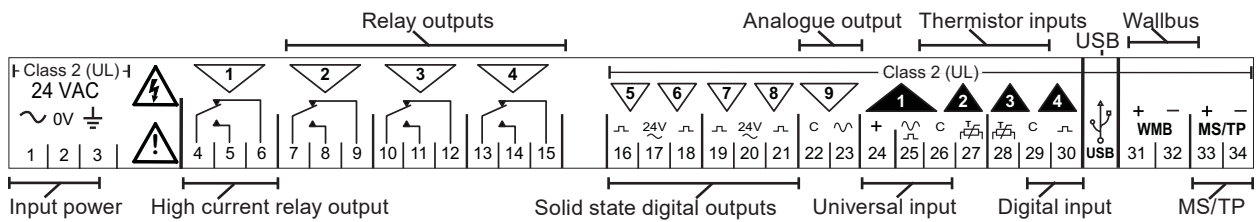

IQECO38

Dimensions as IQECO31/230

Upper Label

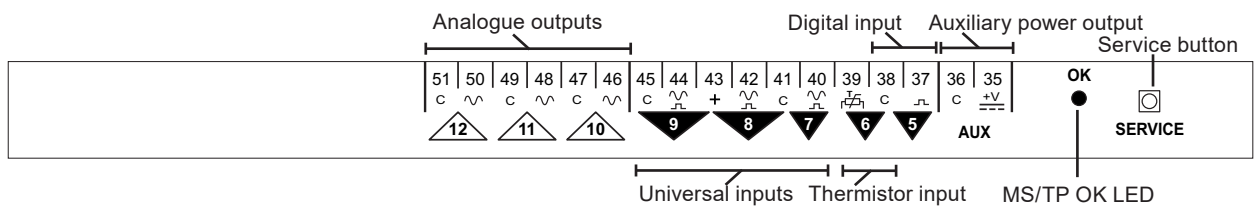

Lower Labels

IQECO38/230

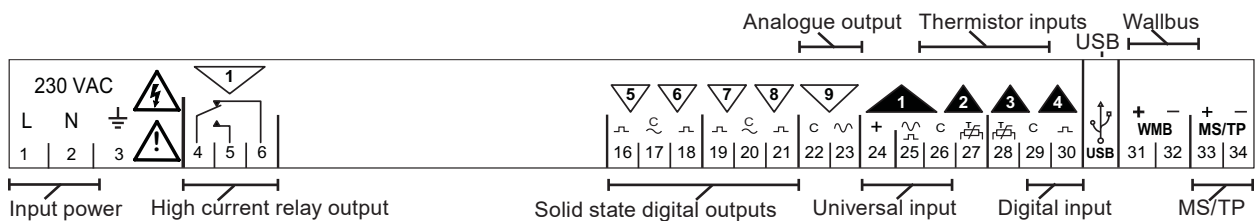



IQECO38/24VAC

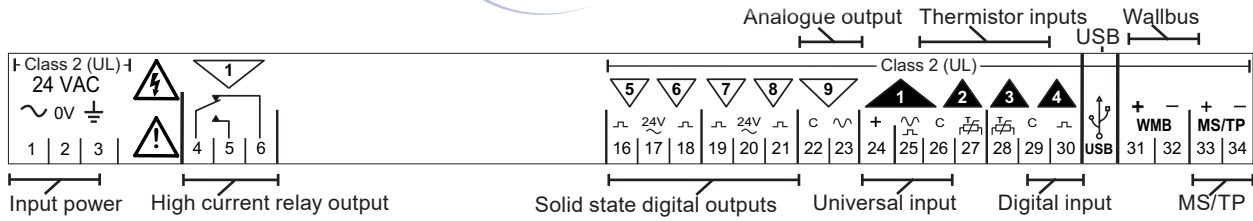

IQECO/IQL Secondary Terminal Cover

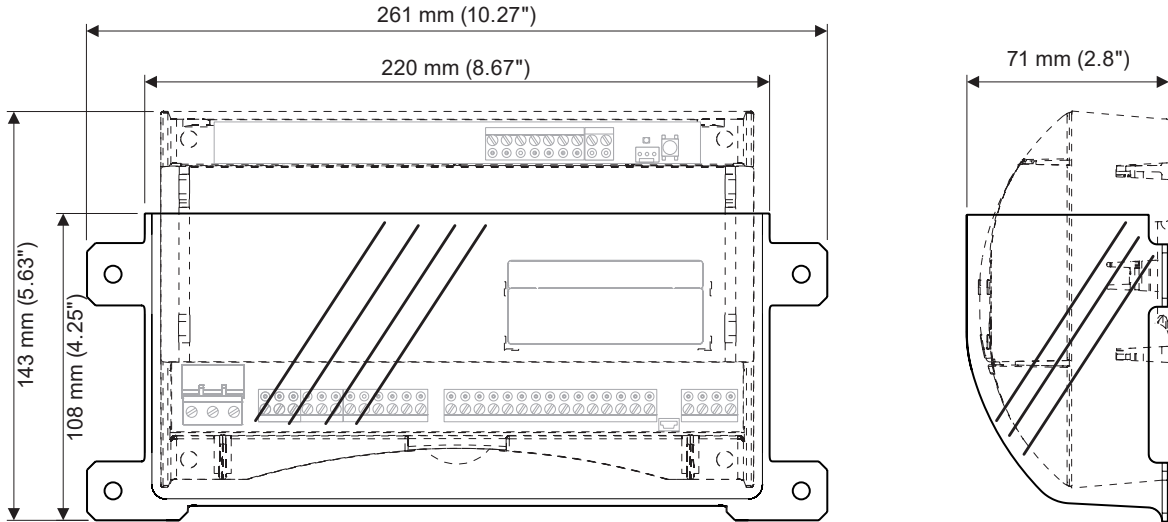

This accessory can be used with IQECO31/230, IQECO32/230 IQECO35, IQECO38 to enable the unit to comply with EN61010-1 without installation in an enclosure.

FUNCTIONALITY

The IQECO functionality can be divided into four sections: System, Hardware, Firmware, and Strategy.

SYSTEM

The IQECO controllers have communication ports for MS/TP, USB (Local Engineering) and Wallbus:

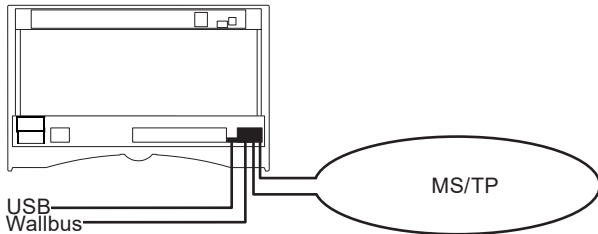

MS/TP

The IQECO can form a Trend LAN with other IQECOs and an IQ4NC over the MS/TP trunk. The IQ4NC acts as a router between Ethernet and the MS/TP trunk allowing IQECOs to communicate with other Trend devices on the Trend network operating on other network media.

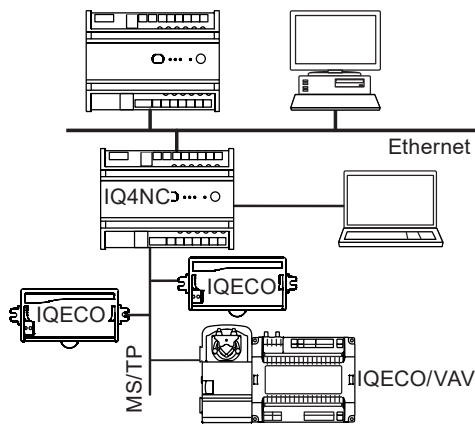

Note: There can only be one IQ4NC on the MS/TP trunk. The LAN number is read-only in the IQECO and is set up when it is installed by the IQ4NC (default LAN 9).

There can be the IQ4NC with up to 64 IQECO controllers or other BACnet devices on the MS/TP trunk. A separate limitation is that the IQECO presents a 1/4 BACnet 'unit' load (ref. EIA-485), as does the IQ4NC. Other manufacturer's devices should be considered as an entire 'unit' load unless otherwise specified. The MS/TP segment supports up to 32 'unit' loads.

Note: Other non-Trend MS/TP master and slave devices can be added to the MS/TP trunk, but their presence may compromise the physical network loading and bandwidth.

The IQECOs's BACnet MAC address will be the same as its Trend device address. Care must be taken to avoid a BACnet MAC address clash. Master devices are required to use BACnet MAC addresses in the range 0 to 127, and slave devices are required to use BACnet MAC addresses 128 to 254.

Using BACnet comms the IQECO is either addressed by its BACnet Device Instance, or its BACnet Network Number and BACnet MAC address. Its BACnet network number is held in the IQ4NC and is normally equal to its LAN number but may be changed. Its BACnet Device Instance will default to a function of the IQECO's Trend LAN Number and Device Address (LAN number x 1000 + Device Address), but may be changed in the IQECO's BACnet Application network module. The IQECOs are BACnet master devices and should use Trend device addresses in the range of 11 to 119.



Note: If communicating with an IQECO through a BACnet router, communication is only possible using BACnet protocol. Trend communications will not work unless the router is an IQ4NC.

MS/TP (master-slave token passing) is based on the two wire RS485 network. It can operate from 9600 baud to 76800 baud (recommended). The baud rate is set in the IQ4NC, and the IQECO automatically sets itself to the same baud rate. All devices on the trunk must use the same baud rate.

All MS/TP devices (e.g. IQECOs, or third party devices) must have their power supply neutral or ground terminal connected to earth, in conjunction with normal safety practices.

The MS/TP trunk should be wired as a straight bus (not loop or star). It should use tinned copper, screened, twisted-pair cable with characteristic impedance between 100 and 130 ohms. Distributed capacitance between conductors shall be less than 100 pF per meter (30 pF per foot).

Distributed capacitance between conductors and screen shall be less than 200 pF per meter (60 pF per foot). Foil or braided screens are acceptable.

The maximum recommended length of an MS/TP segment is 1200 meters (4000 feet) with AWG 18 (0.82 mm²) cross section area cable. The use of greater distances and/or different wire gauges shall comply with the electrical specifications of EIA-485. Cables of a smaller gauge will result in shorter maximum distances. Details of cables are given in the TP/... Twisted Pair Cable Data Sheet (TA200541).

Matched terminating resistors ($\pm 1\%$, 1/4 Watt, range 100 to 130 ohms) are required. The IQ4NC provides network biasing (470 ohms); a maximum of two devices on the network can provide network biasing. Up to 3 repeaters may be used. Each segment must have a single point screen ground. Do not ground the MS/TP screen using a controller terminal. Do not ground both ends of the screen. At connecting points, tie the screen through a terminal.

Failure to comply with these practices will result in significant impairment of the communication performance.

Out of the Box Operation

The IQECO can operate on the MS/TP trunk without an IQ4NC. It will try to form a network with other Trend devices on the MS/TP trunk. As a result attribute type IC comms set up for communication between controllers will operate successfully, and will run its control strategy. BACnet comms will work with default settings. If IQECOs and an IQ4NC are connected as a system 'out of the box' they will form a network; the IQ4NC will give the IQECOs its default LAN address (9), and the controllers will all be accessible to a supervisor or tool via the IQ4NC.

USB (Local Engineering Port)

The USB port allows connection of a PC running IQ™SET (System Engineering Tool). When connected in this way IQSET can communicate across the entire Trend network - see 'Networking' on page 6.

Wallbus

The Wallbus port facilitates the connection of up to 14 devices (e.g. an RD-WMB series room display) depending on the power requirements of the connected devices and the memory available for strategy modules. These devices offer control and indication of parameters such as setpoint, fan speed and occupancy, as well as sensing temperature, humidity and CO₂ levels.

Note: Refer to the Combined Supply section on page 9 for the maximum available Wallbus current.



BACnet Communications

IQECO is certified as a BACnet Application Specific Controller (B-ASC) by WSP Cert. It uses the BACnet trunk as its communications network. It supports the following BACnet communications:

- BACnet devices (workstations, controllers) can communicate with the IQECOs using BACnet protocol.
- BACnet IC Comms Data From modules can receive unconfirmed COV messages from another BACnet device.

IQECO cannot provide BACnet alarm and event notification (BACnet alarms), nor can it provide BACnet trending (plots).

A full specification of the objects, properties, and BIBBS (BACnet Interoperability Building Blocks) supported by the IQECO is given in the IQECO Product Implementation Conformance Statement (TP201091).

Networking

In order to connect to the Trend network an IQECO will create its own internal LAN which includes the following nodes:

- a CNC for its own controller,
- a supervisor CNC (sCNC1) for its USB port,

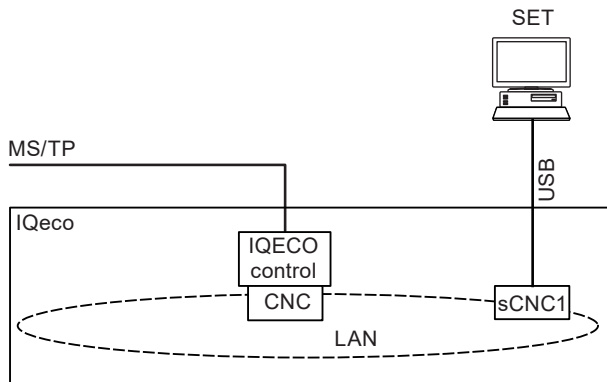

Default CNC Addressing: The IQECO's Trend device address is set up in the factory on a rolling basis in the range 11 to 119. So in a batch of IQECOs, each will have a different device address (printed on the unit's label along with its unique serial number).

An IQECO may be re-addressed by the Addresser Applet (running on a PC connected to the Trend network).

New addresses should be written on the unit's label which has a tear-off adhesive label strip with the serial number (both as text and as a small barcode), and address information which can be used for a paper record e.g. a log book.

sCNC1 Functionality: When a PC running IQSET is connected to the USB port it uses sCNC1. If the USB port address is set to 0 (default), sCNC1 is dynamically created at address 125 for the duration of the IQSET session. When the PC is removed sCNC1 times out and no longer exists. If the address is configured to be non-zero, sCNC1 remains on the network at all times.

IC Comms: The IQECO can communicate with other IQs and BACnet devices using IC Comms. Some IQs running earlier versions of firmware may not support all IC Comms types.

The IQECO is capable of initiating Data To, Global To, or Data From IC Comms. It will respond to Data To, Global To, Data From, and Max, Min Sum and Average comms.

The IQECO is also able to communicate with BACnet devices using IC Comms, the 'Protocol' parameter specifies either Trend or BACnet protocol. The remote controller in the BACnet IC Comms module specifies a Non Trend Device (NTD) module which is set up with BACnet device's BACnet address information. The table below specifies the types of IC Comms with which the IQECO will operate.

Direction	Variable	Initiated by IQ to this IQECO	Initiated in this IQECO to IQ
Data From	Analogue	Yes	Yes
Data From	Digital Byte	Yes	Yes
Data From	Digital Bit	Yes	Yes
Data To	Analogue	Yes	Yes
Data To	Digital Byte	Yes	Yes
Data To	Digital Bit	Yes	Yes
Global To	Analogue	Yes	Yes
Global To	Digital Byte	Yes	Yes
Global To	Digital Bit	Yes	Yes
Minimum	Analogue	Yes	No
Maximum	Analogue	Yes	No
Sum	Analogue	Yes	No
Average	Analogue	Yes	No

IQECO can only send IC Comms to sensors, analogue nodes, knobs, digital inputs digital bits, switches, and digital bytes. IQECO will not send alarm status bits with an analogue IC Comms but can process any that it receives.

HARDWARE

Inputs and Outputs

The I/O channels available vary with the IQECO type as shown in the table below:

	IQECO31/24VAC	IQECO31/230	IQECO32/24VAC	IQECO32/230	IQECO35/24VAC	IQECO35/230	IQECO38/24VAC	IQECO38/230	
Inputs	Universal (UI)	1	1	1	1	3	3	4	
	Digital (DI)	1	1	1	1	2	2	2	
	Thermistor (TI)	2	2	2	2	3	3	3	
Outputs	Relay	HC	0	1	1	1	1	1	
		LC	1	0	0	0	3	3	0
	Solid State Digital	24 Vac	4	0	0	0	4	0	4
		24 Vac synthesised	0	4	0	0	0	4	0
	Analogue	1	1	4	4	1	1	4	
	24 Vdc auxiliary output supply	0	1	1	1	1	1	1	

The standard strategy solutions map the standard inputs as follows:

Label	Input	Type
Discharge temp	IN1	UI
Space Temp	IN2	TI
Setpoint	IN3	TI
Window Contact	IN4	DI
PB/PIR	IN5	DI
Fan Speed Selection	IN7	UI
Flow/safety	IN8	UI

IQECO standard solutions provide a consistent user interface in that the presentation modules will be the same across all solutions where appropriate. Similarly the input and output channels are consistent.



Input/output cabling: For thermistor, voltage, and current inputs and analogue outputs use 2-wire twisted pair. Screened cable for input and/or output connections is not generally required unless the cable passes through electrically noisy environments. If used the screen must be connected to the local panel/enclosure ground and left unterminated at the far end.

An open collector or open drain must be able to sink 270 μ A. The input is on when the transistor or FET conducts. Polarity must be observed.

Universal Inputs

IQECO31, 32 IN1, IQECO35 IN1, IN7, IN8, IQECO38 IN1, IN7, IN8, IN9

Current input: Used for 4 to 20 mA sources which can be external powered or loop powered (from the Auxiliary Supply Output i.e one of the AUX terminals).

Each input channel will function as one of the following:

- thermistor input,
- voltage input,
- digital input, or
- current input.

The input function is set automatically by the strategy.

Thermistor input (0 to 200 kohm): Used for a thermistor or a potentiometer or fan speed control. The thermistor bridge resistor is 12 kohm with a bridge supply 3.3 V.

Example wiring

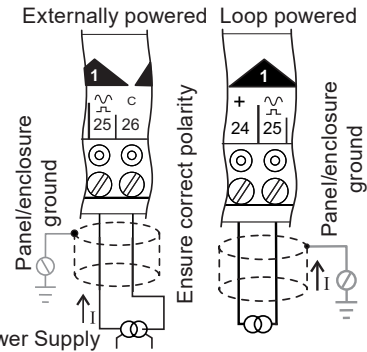

Example wiring

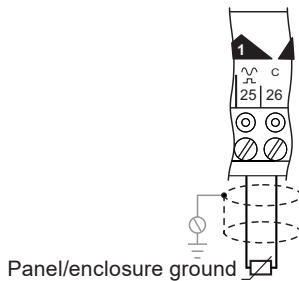

See 'Combined Supply' on page 9 for maximum current available from the '+' and 'AUX' auxiliary supply outputs

Thermistor Inputs

IQECO31, 32: IN2, IN3, IQECO35, 38: IN2, IN3, IN6

Used for a thermistor or a potentiometer or fan speed control. The thermistor bridge resistor is 10 kohm with a bridge supply 3.3 V.

Example wiring

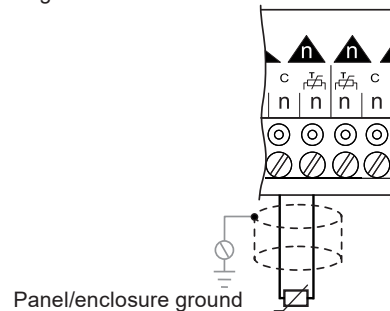

Voltage input: Used with a 0 to 10 Vdc source.

Example wiring

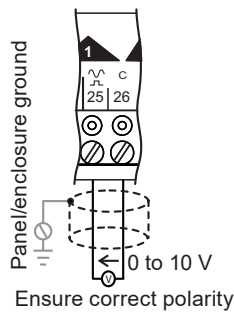

Digital Inputs

IQECO31, 32, IN4, IQECO35, 38 IN4, IN5

The digital input can be used for a volt free contact, or for an open collector/drain:

- The Volt Free Contact has a nominal wetting current of 3mA. The input is on when the contact is closed. There is no polarity.
- The Open Collector or open drain (FET) must be able to sink 3 mA. When the transistor or FET conducts, the digital input will be on. Polarity must be observed.

Note: The input resistance of the voltage input is different from IQ3 and IQ4 controllers, ensure the correct scaling is used.

Digital input: Used for a volt free contact, or for an open collector/drain.

Example wiring

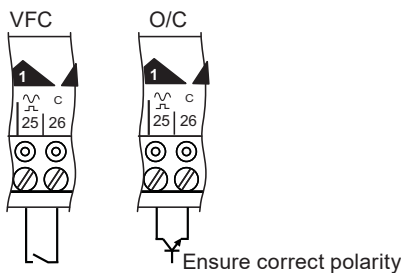

Example wiring

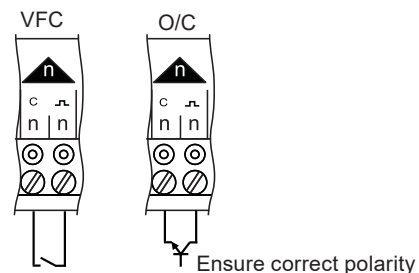

The volt free contact has a nominal wetting current of 270 μ A. The input is ON when the contact is closed. There is no polarity.



Relay Outputs

IQECO31, 32, 38 OUT1, IQECO35 OUT1, OUT2, OUT3, OUT4.

/230: All /230 controllers except IQECO32 have four synthesised 24 Vac outputs. Terminals and example wiring.

All relays are changeover except IQECO31/24VAC which are make only (using terminals 4, 5).

All relays rated at 250 Vac. OUT1 rated at 5 A on IQECO31/24VAC and 8 A on IQECO31/230 and IQECO32. For IQECO35, and 38 OUT2, 3, 4 are rated at 5 A.

Note: To meet safety requirements, for the 4 relays (OUT1 to OUT4) on IQECO35, those being used must all switch either low voltage or mains and not a mixture of the two. If switching mains, they must all switch the same phase and polarity.

Arc suppression is recommended, see Relay Output Arc Suppression Installation Instructions (TG200208).

Ensure that external circuits are suitably protected against fault currents that would exceed the ratings for the switching circuits provided in this product.

Example wiring

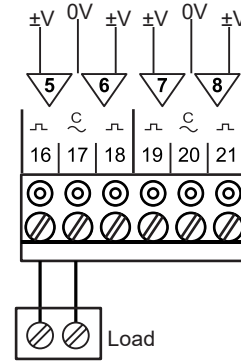
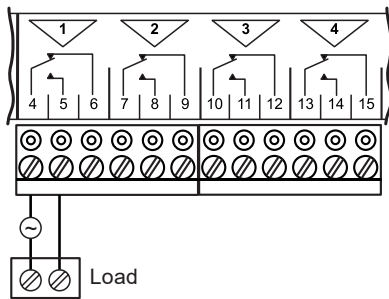

The electrical characteristic of the synthesised 24Vac output is approximately as shown below. Loads should be assessed against this before they are used with /230 controllers.

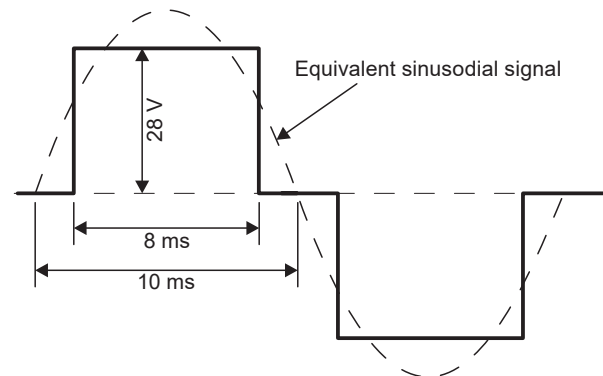

Solid State Digital Outputs (not IQECO32) (OUT5, OUT6, OUT7, OUT8)

Each output provides an independent 24 Vac feed for driving 24 Vac loads, such as thermic actuators, and raise lower actuators, e.g. those in the Trend range of products.

The maximum total current available on all IQECO variants with all four outputs energised is 400 mA at temperatures between -40°C (-40°F) and +40°C (+104°F), and 300 mA at temperatures between +40°C (+104°F) and +60°C (+140°F). Each output can individually deliver the full current available. However, the available current is shared between all the outputs therefore each output must be considered for any application.

For example, if one Digital Output delivers 400 mA, then the other three outputs do not have any current left to deliver.

/24VAC: All /24VAC controllers except IQECO32 have four 24 Vac outputs. Terminals and example wiring.

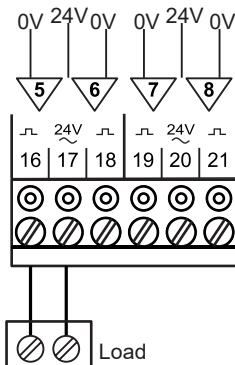

For time proportioning drivers (in power managed mode) a 'soft start' of the above waveform is implemented to allow for the large inrush currents of thermic actuators.

Note: Certain types of actuator which require a direct 24 Vac supply (e.g. spring return) may not be suitable for powering from IQECO/230 units and may require a separate 24 Vac supply.

Analogue Outputs

IQECO31, 35 OUT9, IQECO32, 38 OUT9 OUT10, OUT11, OUT12

Provides 0 to 10 Vdc, see 'Combined Supply' on page 9 for maximum current. Example wiring.

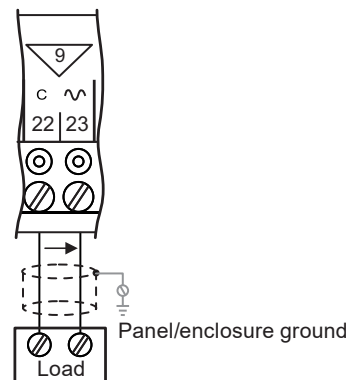

Use 2-wire twisted screened cable for wiring the outputs, with the screen connected to the panel/enclosure ground and unterminated at far end. Connect the return to the C terminal (e.g. 22 C) not to an input common.



Auxiliary Supply Output

Available on all units except IQECO31/24VAC. This output can be used to supply I/O devices (e.g. sensors). It provides 21 Vdc $\pm 10\%$ from AUX terminals - see 'Combined Supply' on page 9 for maximum current. Example wiring

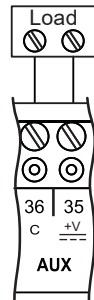

Note: All '+' terminals (terminals 24 and 43) also provide a 21 Vdc auxiliary supply.

Combined Supply

The IQECO's combined supply provides the power for:

- Analogue outputs (AO),
- Loop power to the sensors ('+' terminals 24 & 43)
- Auxiliary supply terminals (AUX terminal)
- Wallbus

The maximum current available from each terminal varies according to the IQECO model and ambient operating temperature, as shown:

Terminal	-40°C to +40°C -40°F to +104°F	+40°C to +60°C +104°F to +140°F
IQECO31/24VAC		
23 AO	20 mA	10 mA
24 Loop power	20 mA	
31 WMB	10 mA	
IQECO31/230		
23 AO	20 mA	10 mA
24 Loop power	20 mA	
31 WMB	10 mA	
35 AUX power	10 mA	
IQECO32/24VAC		
23 AO	20 mA	10 mA
46 AO	20 mA	
48 AO	20 mA	10 mA
50 AO	20 mA	
24 Loop power	20 mA	
31 WMB	10 mA	
35 AUX power	30 mA	
IQECO32/230		
23 AO	20 mA	10 mA
46 AO	20 mA	
48 AO	20 mA	10 mA
50 AO	20 mA	
24 Loop power	20 mA	
31 WMB	10 mA	
35 AUX power	30 mA	10 mA
IQECO35/24VAC		
23 AO	20 mA	10 mA
24 Loop power	20 mA	
43 Loop power	40 mA	
31 WMB	10 mA	
25 AUX power	30 mA	

Terminal	-40°C to +40°C -40°F to +104°F	+40°C to +60°C +104°F to +140°F
IQECO35/230		
23 AO	20 mA	10 mA
24 Loop power	20 mA	
43 Loop power	40 mA	20 mA
31 WMB	10 mA	
35 AUX power	30 mA	10 mA
IQECO38/24VAC		
23 AO	20 mA	10 mA
46 AO	20 mA	10 mA
48 AO	20 mA	10 mA
50 AO	20 mA	10 mA
24 Loop power	20 mA	
43 Loop power	60 mA	
31 WMB	10 mA	
35 AUX power	5 mA	
IQECO38/230		
23 AO	20 mA	10 mA
43 AO	20 mA	10 mA
48 AO	20 mA	10 mA
50 AO	20 mA	10 mA
24 Loop power	20 mA	
43 Loop power	60 mA	20 mA
31 WMB	10 mA	
35 AUX power	5 mA	

If the Wallbus devices connected to the IQECO require a total of more than 10 mA, this must be catered for by reducing supplies to other terminals which use the combined supply.

If the total power requirement of the combined supply is more than the controller can supply it will be necessary to power some of the items using external power sources.

Enclosure

The IQECO is designed for surface or DIN rail mounting. A surface mounted IQECO31/24VAC will comply with EN61010-1.

A DIN rail mounted IQECO31/24VAC or IQECO31/230, IQECO35, IQECO38 must be mounted inside an enclosure rated to at least IP20 or equivalent; to eliminate the need to install in an enclosure the IQECO/IQL Secondary Terminal Cover can be installed over these units. IQECO31/24 cannot be used with the secondary terminal cover, so if it is DIN rail mounted it can only be fitted inside an enclosure. For UL rating all IQECO/24VAC controllers must be mounted inside an enclosure.

The IQECO31/230, IQECO 32, IQECO35, IQECO38 have 4 point surface mounting and the IQECO31/24VAC version has two removable surface mount brackets. All units have a plastic housing with a hinged clear polycarbonate terminal cover. The units are the same size and have the same mounting points as the equivalent IQL controller, but note that the cabling requirements of MS/TP are different to LonWorks.



The units may be mounted vertically in a panel, on the base or vertically side on, but not vertically upside down.

Note: If IQECO31/230, IQECO 32, IQECO35 or IQECO38s are mounted vertically side on the maximum working temperature is derated to 40 °C, (104°F).

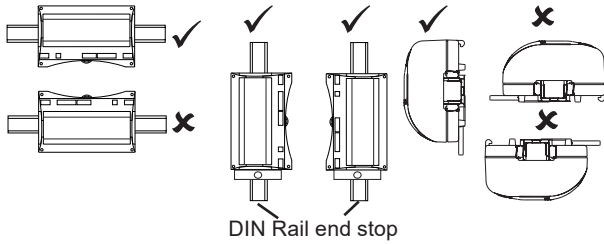

DIN Rail end stop

Input Power Supply

The IQECO has both 230 Vac and 24 Vac input power options.

/230: This option requires 230 Vac ±15%, 50/60 Hz at up to 45VA, which consists of up to 7 VA internal power, plus the power required by the solid state digital (valve or damper) outputs and the Combined Supply Outputs (Wallbus, and analogue outputs see page 9). The IQECO input power earth (ground) terminal (terminal 3) is isolated from the input power neutral, and must be separately earthed (grounded) locally; this ground terminal is internally connected to the IQECO electronics earth (ground).

The 230 V supply must include a dedicated 5 A fuse complying with IEC60269 (BS1362) and a suitably rated switch in close proximity and be clearly marked as the disconnecting device for the unit. A 5 A circuit breaker with high breaking capacity may be used as an alternative.

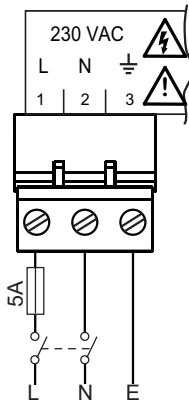

/24VAC: This option requires 24 Vac ±15%, 50/60 Hz, at up to 26VA, which consists of up to 10 VA internal power, plus the power required by the solid state digital (valve or damper) outputs and the Combined Supply Outputs (Wallbus, and analogue outputs see page 9). The 24 Vac uses a half wave rectifier internal power supply unit. Multiple controllers with half wave power supplies may be powered from a single grounded transformer but the supply polarity must be maintained across all units supplied from the same transformer. The 24Vac input power 0V is not internally connected to the earth terminal, therefore both the transformer secondary and the earth terminal (terminal 3) must be connected to earth as shown in the diagram. For UL rating the input power connections must be made using 18 AWG or larger wire rated at least 90°C (194 °F). The 24 V supply must include a suitably rated switch in close proximity and be clearly marked as the disconnecting device for the unit.

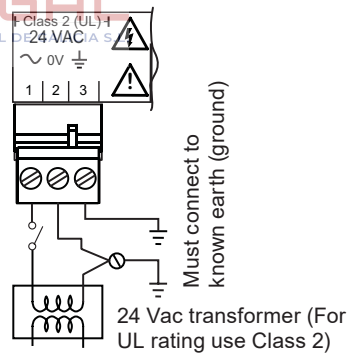

Service Button

Can be used to generate a network message which identifies the IQECO by means of its unique serial number to system tools, e.g. to find its device address and LAN number. An alternative method of identifying the IQECO is to use a barcode scanner.

It can also be used to perform a strategy clear down, to reset the controller to factory defaults, or to enter service button mode (use of these functions is described in IQECO31, 32, 35, 38 Installation Instructions - Configuring (TG201222)).

Service Button Mode: This makes use of virtual input channels (IN101 to IN108) which do not have external connections but can be set to a digital state as a result of service button presses. The virtual input channels can be connected to external type digital input modules in the same way as for the real input channels and then the module outputs may be used in the strategy.

Although the use of the service button in service button mode is determined by the strategy, all the IQECO standard strategy solutions make consistent use of the service button as follows:

Input	Function
IN101	Switch on Water Balancing for LAN
IN102	Switch off Water Balancing for LAN
IN103	Switch on Water Balancing for Unit
IN104	Switch off Water Balancing for Unit
IN105	Switch on Occupation for LAN
IN106	Switch off Occupation for LAN
IN107	Switch on Occupation for Unit
IN108	Switch off Occupation for Unit

The strategy will record the 'on' input to set the function and clear it when the appropriate 'off' input is selected.

Indicator

MS/TP OK: Indicates the status of Trend communications on the MS/TP network. It is also used in service button mode.

Backup

The data (firmware, strategy, parameters) is stored in flash memory which is non-volatile in the case of power failure. Changes to the address module are stored immediately but for other parameter changes, in order to prolong the life of the flash memory, they are written to flash: every 2 hours starting at midnight, after an archive instruction, on data entry by a Wallbus device, or on service button operation. The tools (e.g. IQSET) will send the archive instruction after the parameter changes.

Barcode Label

The label is intended to be collected with the labels from other IQECOs for scanning in when required. The scanner should be able to read 'code 128 auto' work.



FIRMWARE

The firmware in the IQECO controls its basic functionality and provides a range of modules that can be configured to produce a control strategy.

Modules

The range of modules provided in the IQECO's firmware are listed in the table below. Full details of each module can be found in the IQECO Configuration Manual (TE201089).

Module	Max. number of Modules	Note
Address	1 (fixed)	④
Alarm Destination	2 (Flexible)	
Alarm Group	Flexible	
Alarm Route	Flexible	
Alarm Log	1 (fixed)	①
Analogue Node	Flexible	
Digital Byte	Flexible	
Digital Input	Flexible	
Directory	Flexible	
Display	Flexible	
Driver	Flexible	
Function	Flexible	
IC Comms	30 (Flexible)	②
Interface	14 (Flexible)	③
I/O Module	1	③
Knob	Flexible	
Logic	Flexible	
Loop	Flexible	
Network	2 (fixed)	④
	1	③
NTD	32 (Flexible)	
Option	1 (fixed)	
Plot	20 (Flexible)	
Program	1 (fixed)	④
Sensor	Flexible	
Sensor type (Fixed)	12 (fixed)	
Sensor type	100 (Flexible)	
Sequence	1 (fixed) 200 steps	
Switch	Flexible	
Time	1 (fixed)	④
User	1 (fixed)	
Notes:		
① Holds up to 10 alarms		
② Includes BACnet comms and BACnet U-COV support.		
③ For Wallbus devices.		
④ These modules are always present.		

The quantity of each type of module may be adjusted to match the requirements of the application subject to the following:

- A maximum of 300 modules in total. An empty IQECO contains address, time, program, and two network modules which reduce the additional number of modules to 295.
- A maximum for each type of module (shown in table above), and
- The IQECO's memory capacity. If the limit is exceeded SET will prohibit the creation of further modules.

Plot Modules

The IQECO's Plot modules can plot any connectable module output (analogue or digital). IQECO firmware only provides synchronised Plot modules.

The maximum number of records for a plot is 1000 (5000 log points), but maximum total records shared between all Plot modules is 2000. The plots can be retrieved as either single (max error 1%) or double (max error 0.01%) precision if the supervisory software allows.

Fixed Sensor Type Modules

The 12 fixed sensor types are accessed by setting up the appropriate Sensor Type module number in the sensor module.

Module No.	Name	Description
101	10kTherm DegC TBTS	Scales standard Trend thermistor (10kohm at 25°C).for working range 0 to 40 °C
102	Knob TB 0.5 deg trim	For standard TB sensor knob (1k to 10kohm, -0.5 to +0.5)
103	Fan TBTS/KEF	TB/TS/KEF fan speed scaled to enumeration (0, 1, 2, 3, 4 for off, Lo, Med., Hi, Auto respect.)
104	Current 4-20ma	Scales 4 to 20 mA to 2 to 10
105	Volts 0-10V	Scales 0 to 10 V to 0 to 10
106	Onboard DP 1.5inwc	IQECOVAV differential pressure sensor output scaled to 0 to 1.5 inwc
107	Onboard DP 375Pa	IQECOVAV differential pressure sensor output scaled to 0 to 375 Pa
108	10kTherm DegF TBTS	Scales standard Trend thermistor (10 kohm at 25 °C).for working range 23 to 122 °F
109	10kTherm DegC OAT	Scales standard Trend thermistor (10kohm at 25 °C) for working range -29 to +104 °C
110	10kTherm DegF OAT	Scales standard Trend thermistor (10 kohm at 25°C) for working range -20 to +220 °F
111	Fan TBTS/KOF	TB/TS/KOF fan speed scaled to enumeration (0, 1, 2, 3, 4 for Off, Lo, Med., Hi, Auto respect.)
112	WMB Prescaled	For RD space sensor passes value into strategy unchanged

Firmware Upgrades

New versions of firmware may be made available from time to time to change or add functionality or to provide support for new products.

Firmware can be upgraded over the network via the IQ4NC using the Firmware Upgrade Applet.

Time Module

The Time module is supported by a software clock. It responds to time synchronisation from an IQ3/IQ4 timemaster (not IQ2). It requests time synchronisation when the IQECO powers up.

Alarms

The IQECO Configuration Manual (TE201089) fully describes alarms. The following alarms can be generated if the appropriate alarm modules are set up (group, route, destination modules):

Digital Input Alarms

Alarm	Code
DIGIN OFF occurred	DI=0
DIGIN OFF cleared	CDI0
DIGIN ON occurred	DI=1
DIGIN ON cleared	CDI1



Sensor Alarms

Alarm	Code
SENSOR FAIL occurred	OUTL
SENSOR FAIL cleared	COUT
INPUT ERROR occurred	READ
INPUT ERROR cleared	O/K
HIGH VALUE occurred	HIGH
HIGH VALUE cleared	CHIH
LOW VALUE occurred	LOW
LOW VALUE cleared	CLOW

Loop Alarms

Alarm	Code
Setpoint Deviation	SDEV
Setpoint Clear	CSDV

They are same format as IQ alarms.

Note: The MS/TP network alarms are generated by the IQ4NC.

Identification

The IQECO will identify itself as an IQECO to w comms.

Security

The IQECO can be protected by setting up the User module.

Power Management

Power Management is used to minimise the effect of thermic actuator inrush currents on the IQECO's peak current consumption. It is applied to time proportional driver modules and will stagger the turn on times of the pulse modulated waveforms between the drivers so that power will be applied to the outputs in sequence, and not at the same time.

In addition for /230 variants of IQECO31, 32, 35, and 38 only, if this feature is selected, power will not be applied to time proportional driven solid state output channels immediately but will be ramped up over the first 12 s.

The Address module's 'Power Managed' parameter is used to enable or disable the power management feature.

R/L Sync Mode

Raise lower synchronisation is used to ensure that the actuator without any positional feedback is at a defined position. The raise lower driver will attempt to do this in normal running by driving for the calculated time to reach the appropriate end stop plus full scale drive time when the input is either zero or 100%.

The Address module's 'R/L Sync Mode' parameter enables further synchronisation for all raise/lower drivers in the IQECO to occur at midnight, power on, or soft restart by driving the actuator closed for 1.5 times its full scale drive time to ensure it's fully closed. It can be set to either 'Disabled', 'Automatic', or 'Automatic Address Staggered'.

If 'Automatic Address Staggered' is selected, in order that all VAV units in a system do not operate their valves and dampers simultaneously, the controllers on the LAN will stagger their raise lower driver synchronisation according to their device address. This will delay the synchronisation between 0 s to about 11 minutes 26 s according to the address.

Each Raise/Lower Driver module has a 'Position Sync' parameter. The raising edge of this input will cause that driver to perform synchronisation immediately. This enables the synchronisation to occur under strategy control whenever it is required.

In order to operate as a controller, the modules provided by the firmware must be configured to define the way the controller is to control the connected equipment. This configuration is known as the strategy. Strategies are configured using the System Engineering Tool (IQSET).

This produces a strategy file (*filename.IQe*) that can be downloaded to the controller to define its operation. This file consists of all the strategy module instances, their parameters, and links. When this is downloaded it is stored in the controller and then run using the controller firmware.

For details of using IQSET see the System Engineering Tool Manual (TE200147).

IQECOs can be purchased either as a fully programmable unit, or as fixed strategy.

Fixed Strategy

Fixed strategy IQECOs can be configured with a strategy from a defined library of strategies within the IQSET standard strategy solutions. Each standard strategy has both imperial and metric versions. There are three libraries of strategy: Entry, Basic, and Plus and the fixed strategy controller is tagged with the library it is allowed to run. The library a particular controller is able to use is displayed in IQSET's Device View.

When a strategy is downloaded to a fixed strategy controller, the old strategy is stopped while the new strategy is validated. If the strategy validation fails, the old strategy is restarted; if the new strategy is validated, then it is loaded. The validation checks that the strategy is from the correct library and that it has not been structurally modified.

Programmable

This IQECO version is fully programmable using IQSET. A programmable controller may be supplied with a standard strategy, or with no strategy. The standard strategies are available in IQSET as solutions and can be downloaded directly or modified as required in the normal way.

Custom

The IQECO can be supplied with a strategy written by the customer. Trend will supply the strategy already downloaded into a programmable IQECO saving time on site. For this option the customer strategy must be supplied with the order; Trend will not test the strategy it will only ensure that the strategy supplied with the order can be successfully loaded into the controller.



Standard Strategies

Fixed strategy controllers can be re-configured using a standard strategy solution from the same library by downloading from IQSET. Programmable controllers may also be re-configured using any of the strategy solutions. In both cases the solution may not be compatible with the controller variant.

The table shows the compatibility of the standard solutions with both the IQECO variants, and which library the solution is in.

Strategy	eu.bac	Library			IQECO		
		Entry	Basic	Plus	31	35	38
FCU 1 Speed Fan AR2			✓	✓	✓	✓	✓
FCU 1 Speed Fan WR2	✓		✓	✓	✓	✓	✓
FCU 1 Speed Fan WR4	✓		✓	✓	✓	✓	✓
FCU 1 Speed Fan WT2	✓		✓	✓	✓	✓	✓
FCU 1 Speed Fan WT4	✓		✓	✓	✓	✓	✓
*FCU 3 Speed Fan AR2		✓	✓	✓	✓	✓	✓
FCU 3 Speed Fan WR2	✓	✓	✓	✓	✓	✓	✓
FCU 3 Speed Fan WR4	✓	✓	✓	✓	✓	✓	✓
FCU 3 Speed Fan WT2	✓	✓	✓	✓	✓	✓	✓
FCU 3 Speed Fan WT4	✓	✓	✓	✓	✓	✓	✓
FCU 3 Speed Fan AR2 AUX			✓	✓	✓	✓	✓
FCU 3 Speed Fan WR2 AUX	✓		✓	✓	✓	✓	✓
FCU 3 Speed Fan WR4 AUX	✓		✓	✓	✓	✓	✓
FCU 3 Speed Fan WT2 AUX	✓		✓	✓	✓	✓	✓
FCU 3 Speed Fan WT4 AUX	✓		✓	✓	✓	✓	✓
FCU 3 Speed Fan AR2 E			✓	✓	✓	✓	✓
FCU 3 Speed Fan WR2 E	✓		✓	✓	✓	✓	✓
FCU 3 Speed Fan WR4 E	✓		✓	✓	✓	✓	✓
FCU 3 Speed Fan WT2 E	✓		✓	✓	✓	✓	✓
FCU 3 Speed Fan WT4 E	✓		✓	✓	✓	✓	✓
FCU 3 Speed Fan AR2 E99			✓	✓	✓	✓	✓
FCU 3 Speed Fan WR2 E99			✓	✓	✓	✓	✓
FCU 3 Speed Fan WR4 E99			✓	✓	✓	✓	✓
FCU 3 Speed Fan WT2 E99			✓	✓	✓	✓	✓
FCU 3 Speed Fan WT4 E99			✓	✓	✓	✓	✓
FCU Electronically Commutated Fan AR2			✓	✓	✓	✓	✓
FCU Electronically Commutated Fan WR2	✓		✓	✓	✓	✓	✓
FCU Electronically Commutated Fan WR4	✓		✓	✓	✓	✓	✓
FCU Electronically Commutated Fan WT2	✓		✓	✓	✓	✓	✓
FCU Electronically Commutated Fan WT4	✓		✓	✓	✓	✓	✓
Chilled Ceiling WR2	✓	✓	✓	✓	✓	✓	✓
Chilled Ceiling WT2	✓	✓	✓	✓	✓	✓	✓
Chilled Ceiling WR4	✓	✓	✓	✓	✓	✓	✓
Chilled Ceiling WT4	✓	✓	✓	✓	✓	✓	✓

Strategy	eu.bac	Library			IQECO		
		Entry	Basic	Plus	31	35	38
FCU Electronically Commutated Fan WT2 - Seasonal Heating	✓			✓		✓	
FCU Electronically Commutated Fan WR4 - Seasonal Heating	✓			✓		✓	
FCU Electronically Commutated Fan WT4 - Seasonal Heating	✓			✓		✓	
FCU 3 Speed Fan WR2 - Seasonal Heating	✓		✓	✓	✓	✓	
FCU 3 Speed Fan WT2 - Seasonal Heating	✓		✓	✓	✓	✓	
FCU 3 Speed Fan WR4 - Seasonal Heating	✓		✓	✓	✓	✓	
FCU 3 Speed Fan WT4 - Seasonal Heating	✓		✓	✓	✓	✓	

The compatibility applies to fixed and programmable controllers. The 3 Speed Fan strategies are only compatible with IQECO35 (because they use the 3 standard relay outputs). They can be downloaded to IQECO31, 32, or 38 where the 3 fan control outputs will be ignored.

Fixed strategy controllers can only use strategies from their library. However, there is a version of each strategy in the libraries superior to its own. For example, the FCU 3 speed fan AR2 strategy can only be purchased as an entry level strategy, but can be downloaded into an IQECO fixed for either a basic or plus library. On the other hand the electronically communicated fan strategies are purchased as a plus level strategy and cannot be loaded into an IQECO fixed for either a entry or basic library.

All the above strategies use metric units. If one of the above IQECOs is intended for use with imperial units (e.g. for USA), the IQECO should be reprogrammed with the equivalent strategy in imperial units; these can be installed in IQSET by selecting a custom installation.

Water Balancing

The standard strategies include water balancing for use on water side systems for balancing and flushing. The raise/lower (floating point) and time proportional outputs are set to 100% until the water balancing is complete. They make use of service button mode with a virtual input channel to switch water balancing on and another virtual input channel to switch water balancing off.

Note: Water balancing shouldn't be used on air side systems.

eu.bac Certified Strategies

Most strategies, are eu.bac certified and tested to EN15500. The eu.bac certification is only valid for 230Vac IQECOs. For more details of eu.bac certification refer to the 'IQECO EUBac Information Sheet' (TP201336).

Note: eu.bac certification does not apply to IQECO 32.



FIELD MAINTENANCE

The IQECO requires no routine maintenance. Other than opening the hinged flaps to gain access to terminals and the service button, the unit should not be opened.



WARNING: Contains no serviceable parts. Do not attempt to open the unit. Failure to comply may cause damage to the unit.

DISPOSAL

COSHH (Control of Substances Hazardous to Health - UK Government Regulations 2002) ASSESSMENT FOR DISPOSAL OF IQECO31, 32, 35, 38 BACnet Controllers.

RECYCLING

All plastic and metal parts are recyclable. The printed circuit board may be sent to any PCB recovery contractor to recover some of the components for any metals such as gold and silver.



WEEE Directive:

At the end of their useful life the packaging, and product should be disposed of by a suitable recycling centre.

Do not dispose of with normal household waste.
Do not burn.



COMPATIBILITY

Supervisors and Displays: 963 v3.4 or greater, 916 v1.3, IQView v1.4 or greater, IQView8.

Wallbus: RS-WMB, RD-WMB, RV-WMB, Ex-Or DALI64SYLKPSU (Check power requirements, see 'Combined Supply' on page 9).

Utility Software: IQSET v7.50 or greater.

Controllers: IQECOs directly and IQ1, IQ2, IQ3, IQ4 via IQ4NC. IQL via IQ4NC and XTEND.

IC Comms: IQ4, IQ3, IQ2, IQECO, IQL, and IQ1 (v3 onwards).

BACnet Devices: The IQECO is certified as a BACnet Application Specific Controller (B-ASC) by WSP Cert. Compatibility is defined in the IQECO Product Implementation Conformance Statement (TP201091).

TB/TS Series: The TB/TS provides a wall mounting thermistor space sensor that can be connected to an IQECO input. The TB/TS/K also provides setpoint adjustment as a potentiometer input. The TB/TS/KO has the TB/TS/K features plus an occupation override push button. The TB/TS/KOF is similar to the TB/TS/KO but also has fan speed control. The TB/TS/KOSF is similar to the TB/TS/KOF but also has additional occupation status LEDs. These sensors can be used with the standard strategies.



INSTALLATION

The IQECO is designed to be mounted either on DIN rail or flat surface (IQECO31/24 has 2 hole mounting, IQECO31/230, IQECO32, IQECO35, IQECO38 have 4 hole mounting,). A surface mounted IQECO31/24VAC will comply with EN61010-1. A DIN rail mounted IQECO31/24VAC or IQECO31/230, IQECO35, or IQECO38 must be mounted inside an enclosure rated to at least IP20 or equivalent; to eliminate the need to install in an enclosure the IQECO/IQL Secondary Terminal Cover can be installed over these units.

The installation procedure involves:

Mounting the controller in position	Testing strategy by using controller simulation mode in IQSET
Connecting power input, do not power up	Downloading strategy (library strategy, or programmable controllers only)
Earthing (grounding) controller	Connecting I/O
Connecting USB if required for tool	Configuring strategy parameters if required
Connecting MS/TP BACnet network	Testing controller
Terminating the I/O channels, leave unconnected.	Checking BACnet communications using IQSET
Powering up	Configuring rest of system and test system
Setting up address using Addresser Applet	
Checking network	
Configuring the strategy (programmable controllers only)	

A full description of installing the unit is given in the IQECO31/24VAC Installation Instructions - Mounting (TG201223), IQECO31/230 Installation Instructions - Mounting (TG201224), IQECO32, 35, 38 Installation Instructions - Mounting (TG201177), and IQECO31, 32, 35, 38 Installation Instructions - Configuration (TG201222).

All /24VAC units are UL rated as 'UL916, listed open energy management equipment'. For UL rating all IQECO controllers must be mounted inside an enclosure.

Installation of the secondary terminal cover is given in the IQECO/IQL Secondary Terminal Cover Installation Instructions (TG201243).

Note: IQECO31/24 cannot be used with the secondary terminal cover, so if it is DIN rail mounted it can only be fitted inside an enclosure.

If supplied with an installed strategy, also see appropriate strategy data sheet.



ORDER CODES

CONTROLLERS

[Controller Type]/[Prog]/BAC/[Strat]/[Power]

Where [Strat]=[Fan][Type][Relay][Library], 'CUSTOM' or 'NOSTRATEGY'

[Controller Type]	IQE31	IQECO31 controller
	IQE32	IQECO32 controller
	IQE35	IQECO35 controller
	IQE38	IQECO38 controller
[Prog]	C	Supplied with custom strategy
	F	Supplied with fixed strategy as specified by [Strat]
[Library]	E	Entry
	B	Basic
	P	Plus
	NOSTRATEGY	Specified controller with no strategy. Only available on fixed strategy and programmable controllers. If ordered as fixed the controller will be able to use all strategies from the 'Plus' library.
	CUSTOM	The name of the custom strategy.
[Power]	230	230 Vac input power supply
	24VAC	24 Vac input power supply

AVAILABLE ORDER CODES

The following are available with [Prog]=C.

IQE31/C/BAC/<Custom>/<Power>	IQECO31 with custom strategy, programmable only
IQE32/C/BAC/<Custom>/<Power>	IQECO32 with custom strategy, programmable only
IQE35/C/BAC/<Custom>/<Power>	IQeco35 with custom strategy, programmable only
IQE38/C/BAC/<Custom>/<Power>	IQeco38 with custom strategy, programmable only

UPGRADE TO PROGRAMMABLE CONTROLLER

IQE/PROG/UP

Upgrade licence to convert a fixed strategy controller to a programmable controller.

ACCESSORIES

IQeco/IQL Secondary Terminal Cover

Plastic cover that can be fitted over the IQeco31/230, IQeco32, IQeco35, 38 so that they comply with EN61010-1 without the need to fit them in a panel.





SPECIFICATIONS

ELECTRICAL

Power Input	
/230	:230 Vac $\pm 15\%$, 50/60 Hz, 45 VA max
/24VAC	:24 Vac $\pm 15\%$, 50/60 Hz, 26 VA max
Fusing	:No replaceable fuses required.
Power Fail Protection	:Non-volatile flash memory.
Clock Accuracy	:Software clock (1 second resolution)
Cycle Time	:Sequence table <1s.

BACnet MS/TP

Distance	:Dependent on cable type and wire gauge as specified in EIA-485.
Load	1/4 BACnet 'unit' load
Signalling	:RS485 signalling transceiver standard
Baud rate	:9k6 to 76k8 baud.
Termination	:100 to 130 ohms matched each end
Addresses	:11 to 119 (recommended)

USB Local Engineering Port

Transmission	:USB 2.0.
Distance	:5 m (5 yards) maximum.
Address (sCNC1)	:1 to 119, (2, 3 and 10 not permitted).

Wallbus

Cable Type	:Unscreened twisted pair.
Distance	:60 m (200 ft) maximum.
Polarity	:Independent
Supply Current	:See 'Combined Supply' on page 9.
Number of Devices	:14 maximum dependant on available controller memory and power requirements of connected devices.

Inputs/Outputs

Number of Channels :See table on page 6.

Universal Inputs

Function	:Measuring voltage, current, thermistor or digital input (function set by strategy)
Input Noise Rejection	:Minimum 60 dB series mode rejection at input power supply frequency.

Input resolution :12 bit resolution.

Voltage Input

Input range	:0 to 10 V
Input resistance	:9.4 k Ω
Accuracy	: $\pm 0.5\%$ typical ($\pm 2\%$ maximum).

Current Input

Input resolution	:12 bit resolution (4096 steps - effective).
Input range	:4 to 20 mA
Input resistance	:120 ohms
Accuracy	: $\pm 0.5\%$ typical ($\pm 2\%$ maximum).

Thermistor Input

Resistance	
Input range	:0 to 200 k Ω
Accuracy	: $\pm 0.5\%$ typical at 25 °C (1 k Ω to 20 k Ω).
Bridge resistor	:12.2 k Ω
Bridge supply	:3.3 V.

Digital input

Input voltage	:3.3 V supply through 12 k Ω
Count rate	:30 Hz (pulse width ≥ 16.6 ms)
Volt free contact	:Wetting current 270 μ A nominal. (ON = closed contact)

Open collector/drain :Must be able to sink 270 μ A. Must be earthed (grounded) to same earth as IQeco. Polarity dependent. (ON = transistor/FET conducts)

Digital Inputs

Function	:Detection of volt-free contact operation or open collector/drain type sources.
Input voltage	:5 V supply through 1.5 k Ω .
Count rate	:30 Hz (pulse width ≥ 16.6 ms)
Volt free contact:	Wetting current = 3 mA nominal. (ON = closed contact.)

Open collector/drain: Must be able to sink 3 mA . Must be earthed to same earth (ground) as IQeco. Polarity dependent. (ON = transistor/FET conducts.)

Thermistor Inputs

Function	:Potentiometer, thermistor, fan speed control
Input Noise Rejection	Minimum 60 dB series mode rejection at input power supply frequency.
Input resolution	:12 bit resolution
Resistance	
Input range	:0 to 200 k Ω
Accuracy	: $\pm 0.5\%$ typical at 25 °C (1 k Ω to 20 k Ω).
Bridge resistor	:10 k Ω
Bridge supply	:3.3 V.

Analogue Outputs

Function	:Variable control from strategy of valve/damper actuators, voltage to current/pressure converters, relay modules, lighting dimmers, etc.
Voltage range	:0 to 10 Vdc
Maximum current	:See 'Analogue Outputs' on page 8.
Accuracy	: $\pm 0.5\%$ typical ($\pm 2\%$ maximum).

Solid state Digital Outputs

Function	:For use with 24 Vac thermal type actuators, 24 Vac synchronous motors, and 24 Vac relays.
IQeco/24VAC	:Solid state digital outputs equivalent to 24 Vac solid state relays. 24 Vac; for maximum current see 'Solid State Digital Outputs (not IQeco32)' on page 8.
IQeco/230	:Solid state digital outputs equivalent to 24 Vac solid state relays. 24 Vac synthesised; for maximum current see 'Solid State Digital Outputs (not IQeco32)' on page 8.

Relay Outputs

Standard (IQeco31/24VAC)

Relay contacts	:Normally open, make only, single pole relay contacts. 250 Vac at 5 A maximum.
----------------	--

Standard (IQeco35)

Relay output	:Standard current. Changeover relay contacts. 250 Vac at 5 A maximum.
--------------	---

High Current (IQeco31/230, IQeco32, IQeco35, IQeco38)

Relay output	:High current Changeover relay contacts. 250 Vac at 8 A maximum.
--------------	--

Arc suppression circuit (RC) should be fitted for inductive loads, see Relay Output Arc Suppression Installation Instructions (TG200208). UL rating applies up to 30V.

Auxiliary Supply Outputs ('+' terminal on all IQecos, and 'AUX' terminal on IQeco31/230, IQeco32, IQeco35, 38)

Voltage:	21 Vdc $\pm 10\%$
Current (maximum)	:see 'Combined Supply' on page 9.

INDICATORS

MS/TP OK	:Green LED
----------	------------



SPECIFICATIONS (continued)

MECHANICAL

Dimensions (WxHxD)	
IQeco31/24VAC	:170 mm (6.69") x 89 mm (3.5") x 45 mm (1.77")
IQeco31/230, IQeco32, 35, 38	:205 mm (8.07") x 129 mm (5.08") x 63 mm (2.48")
Material	
Box	:PCABS FR
Terminal Cover	:Clear polycarbonate flap
Weight	
IQeco31/24VAC	:209 g (7.4 oz)
IQeco31/230	:494 g (1 lb 1.5 oz)
IQeco32	:554 g (1 lb 3.5 oz)
IQeco35	:554 g (1 lb 3.5 oz)
IQeco38	:514 g (1 lb 2 oz)

Connectors

Power

IQeco31/230, 35, 38	
Connector type	:2 part connector with rising clamp screw terminals.
Cable size	:0.14 to 2.5 mm ² (22 to 12 AWG) cable; 0.82 mm ² (18 AWG) typical.
IQeco31/24VAC	
Connector type	:2 part connectors with wire protection screw terminals
Cable size	:0.14 to 2.5 mm ² (22 to 12 AWG) cable; 0.82 mm ² (18 AWG) typical.

For UL compliance the input power connections must be made using 18 AWG or larger wire rated at least 90°C (194 °F).

Relay

Connector type	
IQeco31/24VAC	:Single part connector with rising clamp screw terminals
All others	:2 part connectors with rising clamp screw terminals
Cable size	:0.14 to 2.5 mm ² (22 to 12 AWG) cable; 0.82 mm ² (18 AWG) typical.

For UL compliance use copper cable only.

Inputs/Outputs, MS/TP, Wallbus, AUX

Connector type	:2 part connectors with wire protection screw terminals
Cable size	:0.14 to 2.5 mm ² (22 to 12 AWG) cable; 0.82 mm ² (18 AWG) typical.

For UL compliance use copper cable only for inputs/outputs.

USB Engineering Port :Micro B connector.

ENVIRONMENTAL

EMC	:EN61326-1: 2006
Immunity	:Table 2 - for equipment intended for use in industrial locations.
Emission	:Class B
Safety	
/24VAC	:EN61010-1: 2010
/230 only	:EN61010-1: 2010, EN 60730-1: 2010
USA/Canada	:/24VAC controllers are UL rated as 'UL916, listed open energy management equipment.
Canada	:CSA22.2 No. 205-M1983 - Signal Equipment
Ambient limits	
Storage	:-40 °C (-40 °F) to +60 °C (140 °F)
Operating	:-40 °C (-40 °F) to +60 °C (140 °F).

Note: For IQeco35/24VAC and IQeco38/24VAC for UL rating operating temperature range is reduced to -40 °C (-40 °F) to +55 °C (131 °F).

Humidity	:0 to 95 %RH non-condensing
Altitude	:< 2000 m (6562')
Pollution degree	2 (Only non-conducting pollution occurs)
Protection	
/230	:IP20 if mounted in an enclosure rated at IP20 or equivalent.
/24VAC	:IP20

CONTROL DETAILS (60730-1)

Control purpose	:Automatic control
Construction	:Independently mounted control
Action	:Type 1B action
Impulse voltage	:2500V

CERTIFICATION CERTIFICATES

CB certificate numbers

IQeco31/230	:NO79379/M2
IQeco32/230	:NO95318
IQeco35/230	:NO79377/M2
IQeco38/230	:NO79378/M2
IQeco31/24VAC	:NO78731/A1/M2
IQeco32/24VAC	:NO95317
IQeco35/24VAC	:NO78732/A1/M2
IQeco38/24VAC	:NO78733/A1/M2

BACnet

eu.bac certificates	
IQeco31/230	212206
IQeco35/230	212205
IQeco38/230	212207

Note: eu.bac certification only applies to /230VAC versions and IQeco32 is not eu.bac certified.

Please send any comments about this or any other Trend technical publication to techpubs@trendcontrols.com

© 2021 Honeywell Products and Solutions SARL, Connected Building Division. All rights reserved. Manufactured for and on behalf of the Connected Building Division of Honeywell Products and Solutions SARL, Z.A. La Pièce, 16, 1180 Rolle, Switzerland by its Authorized Representative, Trend Control Systems Limited.

Trend Control Systems Limited reserves the right to revise this publication from time to time and make changes to the content hereof without obligation to notify any person of such revisions or changes.

Trend Control Systems Limited

St. Mark's Court, North Street, Horsham, West Sussex, RH12 1BW, UK. Tel: +44 (0)1403 211888, www.trendcontrols.com